

CRYOLYS Evolution



USER MANUAL **CRYOLYS Evolution**



RESTRICTED USER LICENSE:

By purchasing or using the Product, the user accepts the terms and conditions of this License in full.

The purchase or use of the Product confers on the User the non-transferable right to use the Product for Research purposes only. The term Research denotes any scientific research programs conducted directly by the User for their own purposes; the User renounces the right to use the Product for the purposes of developing a treatment or diagnostic method as well as any use of the Product for Commercial purposes.

The term «Commercial» includes in particular use of the Product or its Components, (i) for manufacture, (ii) for the provision of services, information or data to a Third Party, (e.g. paid sample testing), (iii) for resale, whether within the context of Research or not, (iv) for quality control or providing quality assurance for the manufacturer of a commercialized product.

The User is not authorized to modify, resell or transfer the Product or its components.

LEGAL INFORMATION:

Bertin Technologies and/or its subsidiaries deny any liability either explicit or implicit and particularly but not exclusively for commercial or individual warranties linked to this document. Except where otherwise provided for by law, neither Bertin Technologies nor its subsidiaries can be held liable, either in contractual or criminal law, and in terms of a guarantee or under any other regime that may be, for any damage in whatever form which may occur particularly but not exclusively as a result of the use of this document.

Neither Bertin Technologies, nor its employees, can be held liable for losses or costs resulting from its use. The information contained in this document is provided solely for use with this Bertin Technologies product under the terms and conditions of the Restricted User License. Bertin Technologies is not liable for any use of this information when applied to other products. Bertin Technologies reserves the right to modify this document and make any changes at any time without prior notice.

This liability waiver clause is written and interpreted according to French law. Any legal action relating to the content of this clause is the exclusive jurisdiction of the Courts of Law in Paris, France.

© 2017 by Bertin Technologies.

This document is protected and contains information which is the property of Bertin Instruments. The Bertin Instruments, Precellys® Evolution Touch and Cryolys® Evolution logos are registered trademarks of Bertin Technologies.

BERTIN TECHNOLOGIES
Parc d'activités du Pas du Lac
10 bis, avenue Ampère
78180 Montigny le Bretonneux
France
Tél : + 33 (0)1 39 30 61 60

Cryolys® is a registered trademark of Bertin Technologies.
© 2024 Bertin Technologies All rights reserved
Translated instructions from the French original version

Document reference : CLYS-800-DU002-A

CONTENTS

1	INTRODUCTION
1.1	Safety instructions and recommendations
1.2	Warranty
2	DESCRIPTION OF THE CRYOLYS® EVOLUTION
2.1	Description of the equipment
2.2	Specifications
2.3	Generating cold air
3	INSTALLING THE CRYOLYS® EVOLUTION
3.1	Unpacking and installation
3.2	Packaging and transport
3.3	Storage
4	USE
4.1.	Description of user interface
4.2.	Starting temperature-controlled homogenization
5.	CLEANING AND DECONTAMINATION
5.1	Recommendations
5.2	Decontamination protocol
6.	SUPPORT AND DOCUMENTATION
6.1	Frequently asked questions
6.2	Troubleshooting
6.3	Support
6.4	Disposal
7.	APPENDIX: EXAMPLE OF CE DECLARATION
8.	APPENDIX: ELECTRICAL DIAGRAM



Read carefully user manual before operating.

1. Introduction

Thank you for purchasing a Cryolys® Evolution by Bertin Instruments. The Cryolys® Evolution is a cooling system specifically designed for the Precellys® Evolution Touch. Based on the use of cooled atmospheric air through the sublimation of dry ice, it provides optimal protection for temperature-sensitive molecules such as proteins, small RNAs or even particular chemical compounds by maintaining a temperature between 0 and 10°C. The Cryolys® Evolution is the solution for preserving the molecules in your samples and therefore for obtaining the best possible results.

This user manual includes all the information you need to use and maintain your Cryolys® Evolution. The technical specifications of this product, along with all the information contained in this manual may be modified at any time without prior notice.

1.1. Safety instructions and recommendations

Read this user manual carefully before using your Cryolys® Evolution. If you are in any doubt about the safety of the device, please contact us by email at this address: sample-prep@bertin-instruments.com or contact your local distributor, whose address is listed on our website: Bertin Instruments.

Bertin Technologies cannot be held liable for any damage or injuries caused by using this device in a manner other than that described in this manual.

Reference labels are attached to the device's components. Users must comply with the information printed thereon.

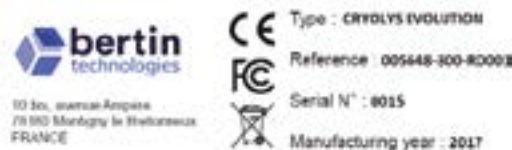

Worldwide Patent pending by Bertin Technologies

1.1.1. Risk of electric shock

As the Cryolys® Evolution is connected electrically to the rear panel of the Precellys® Evolution Touch, usage precautions and recommendations against electric shocks are as described in the Precellys® Evolution Touch User Manual (23405-800-DU002-A).

1.1.2. Biological risks

Always wear the necessary personal protection equipment (PPE) when cleaning any parts soiled by biological samples, for example inside the Precellys® lid.

Note: Refer to the Precellys® Evolution Touch manual (23405-800-DU002-A) as well as to the procedures currently in place in your laboratory



Eye and face protection



Hand and skin protection

1.1.3. Risks linked to dry ice

Dry ice (cardice) is made from an accumulation of carbon dioxide in a solid state with a temperature of -80°C. It sublimates in air into CO₂, a colorless and odorless gas. The principal risks linked to the handling of this product are asphyxia and burns. In order to protect yourself against projectiles and the risk of asphyxia, the user must wear protective gear for the eyes, face and skin. Store and handle dry ice in a ventilated area.



Ensure you are in possession of the safety data sheet covering the risks and precautions linked to the use of dry ice (handling using protective gloves, transport and storage under particular conditions, etc.).



Risk of burns:
Dry ice at -80°C



Risk of asphyxia

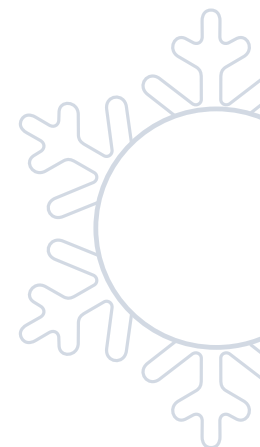



1.1.4 Mechanical risks

The lid is liable to self-closure. We recommend keeping it in the open position with your hand during all operations requiring it to be opened. If not, we recommend closing it.

When opening the lid, please be aware of the risk of pinching between the hinge and the rear of the Precellys® Evolution.



**RISK OF
PINCHING**

1.1.5 Special Safety Symbol

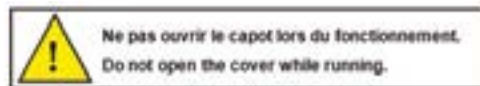

Comply with the safety instructions associated with this symbol.

1.1.6 Recommendations

Any use of this device other than that described in this manual can alter its external protection and damage its internal components.

We recommend that you:

- ▶ Do not install unauthorized components or accessories; this can alter the protection afforded by the device and void its warranty.
- ▶ Do not drop the device: the Cryolys® Evolution module must always sit atop the Precellys® Evolution or on a horizontal surface, or its components may become damaged.
- ▶ Do not handle the device if it is fully or partially dismantled or if it is damaged.
- ▶ Do not invert the connections as this could irreparably damage the connectors.
- ▶ Do not plug the Cryolys® Evolution in to a power supply other than the one supplied by Bertin Instruments.
- ▶ Do not obstruct the fan.
- ▶ **ONLY use sticks of dry ice (do not use nitrogen or H₂O ice).**
- ▶ Do not fill the dry ice container beyond its limit (see «4. How to Use»)
- ▶ Do not ship the device if the container contains dry ice.
- ▶ Do not ship the device in anything other than the original packaging.

1.2. Warranty

The manufacturer's warranty is limited to one (1) year. This warranty is valid from the date the equipment is registered on our website: (www.bertin-instruments.com). This covers failure or malfunction of any of the components in the device where it has been used in compliance with the recommendations contained in this manual.

The warranty does not apply in the following cases:

- ▶ Use or maintenance which does not comply with the instructions contained in this manual.
- ▶ Opening, repair or modification of the device by unauthorized persons.
- ▶ Alteration or removal of the label on which the device's serial number is printed.

Manufacturer:

Bertin Technologies
Parc d'activité du Pas du Lac
10bis Avenue Ampère
78180 MONTIGNY-LEBRETONNEUX
FRANCE

2. DESCRIPTION OF THE CRYOLYS® EVOLUTION

The Cryolys® Evolution is a device designed to keep biological samples in the Precellys® Evolution at a temperature between 0°C and 10°C to avoid any degradation linked to a temperature increase during homogenization. The Cryolys® Evolution allows you to:

- ▶ Keep the sample temperature below 10°C throughout the homogenization process.
- ▶ Control the temperature from the Precellys® Evolution's screen.
- ▶ Protect temperature-sensitive molecules from degradation.

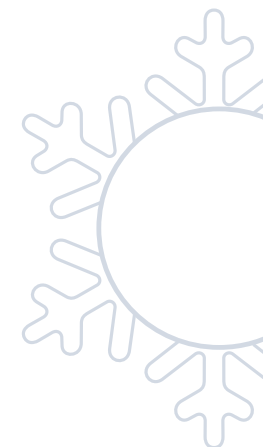



2.1. Description of the equipment

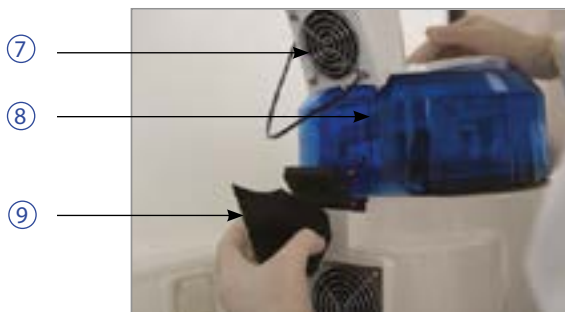
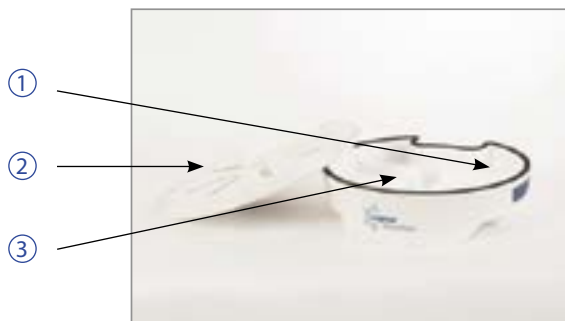

- ① **Main seal:** ensures a good seal between the cover and the module.
- ② **Diffuser Plate:** this is attached to the cover and directs air over the dry ice.
- ③ **Cooling module:** ensures uniform diffusion of cooled air inside the Precellys® Evolution.
- ④ **Module cover:** Encloses the cooling module.
- ⑤ **Locking levers:** allow removal or locking of the cooling module from/to the Precellys® lid.
- ⑥ **Precellys® lid:** its fixed base receives the cooling module.
- ⑦ **Fan:** propels atmospheric air through the module. The four-pin connector must be connected to the back of the Precellys® Evolution.
- ⑧ **Temperature sensor:** measures the temperature inside the Precellys® Evolution and detects whether the module is attached to the Precellys® lid. The three-pin connector must be connected to the back of the Precellys® Evolution.
- ⑨ **Hinge reinforcement:** reinforces the hinge of the Precellys® Evolution in order to support the Cryolys® Evolution.

2.2. Specifications

Weight (empty module)	1.1 kg
Operating temperature	15-30°C
Humidity	15-85% RH
Altitude	< 2,000 m
Operating specifications	
Maximum air flow	1.8 kg
Dry ice reservoir	ON or OFF
Dry ice consumption	Approx. 1.5 kg/30 mins
Minimum dry ice volume	0.5 kg
Noise level	< 60dB
Temperature control	Between 0°C and 10 °C (1°C increments)

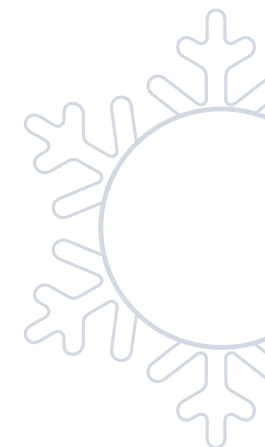



2.3. Generating cold air

Cold air is produced and maintained at the temperature set by the user.

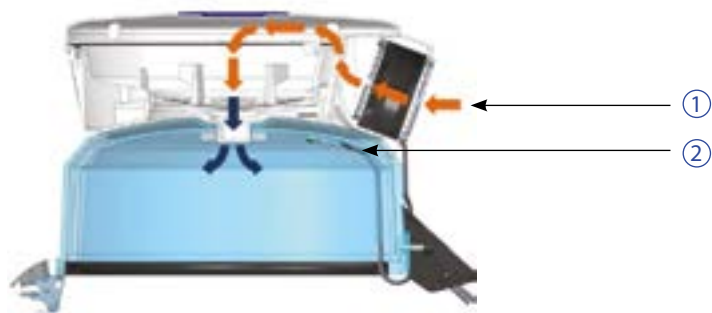

Figure 1: cooling principle

- ① The atmospheric air propelled by the fan is cooled as it travels over the dry ice
- ② The cold air is injected into the tube container via the Precellys® lid

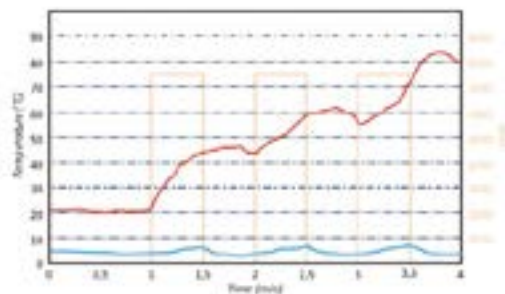

Figure 2: Temperature inside the tubes during homogenization with and without Cryolys® Evolution

- █ Temperature during homogenization without Cryolys® Evolution
- █ Temperature during homogenization with Cryolys® Evolution
- █ Precellys® Evolution homogenization cycles

3. INSTALLING THE CRYOLYS® EVOLUTION

3.1. Unpacking and installation

It is important to check the delivered package carefully and inform your carrier of any damage.

3.1.1. Package contents

The package contains the following items:

- ▶ One Cryolys® Evolution (module + specific Precellys® lid)
- ▶ Two mounting screws attached to the Precellys® lid
- ▶ Hinge reinforcement for the Precellys® Evolution
- ▶ Cable tie
- ▶ USB stick containing Cryolys® Evolution control software
- ▶ User manual
- ▶ CE compliance declaration

3.1.2. Unpacking the package

1. Open the cardboard box.
2. Pull out the inner box using the central handle.
3. Open the inner box and pull out the top foam protector.



4. Check that all components are present.
5. Separate the Cryolys® Evolution from its bottom protector, and place it on a flat surface.
6. Lift the hinge reinforcement out of the bottom protector.

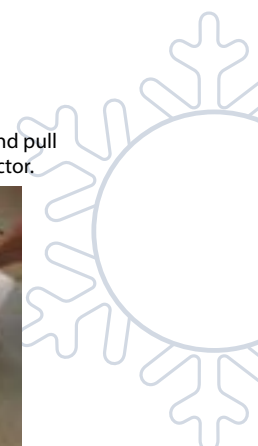



CAUTION - IMPORTANT

Do not hold the Cryolys® Evolution by its cover

3.1.3. Installing the Cryolys® Evolution

Note: Make sure the Precellys® Evolution Touch is disconnected from the power supply before installation.

Required tool: No 5 Allen (hex) key

1. Unscrew the 2 screws on the cover of the Precellys® Evolution

2. Detach the hinge and remove the original cover

3. First remove the cooling module and then place the lid on top of the Precellys® Evolution



4. Insert the hinge reinforcement into the hinge screw holes



5. Gently tighten the 2 screws supplied with the cover



6. Connect both fan and temperature sensor connectors to their respective connections at the back of the Precellys® Evolution.



7. Attach the fan and board interface cables to the hinge reinforcement using the cable tie provided.



3.1.4. Updating the software

In order to optimize the use of your instrument, we recommend always having the latest available software version. You can check the installed software version via the instrument's «settings» menu.



Figure 3: Precellys® Evolution Touch «settings» menu

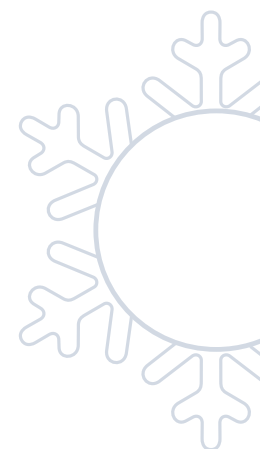

Registering your product will ensure you are informed when new software versions are made available for the Precellys® Evolution Touch. This can be done via the Bertin Technologies website (www.bertin-technologies.com).

1. Insert the USB stick containing the latest version of the software.



2. Turn the Precellys® Evolution Touch on and select »Data manager (USB)« from the Menu.

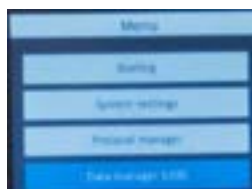

3. Select «Update software version».

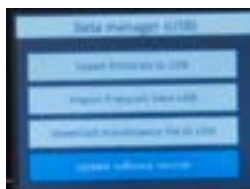

4. Press OK and wait 60 seconds.



5. The Precellys® Evolution will restart automatically.



3.2. Packaging and transport

Before transporting the device, you must:

1. Check that there is absolutely no dry ice inside the module
2. Ensure there is no humidity or, if necessary, dry any humid areas

If you have to transport or ship the Cryolys® Evolution, arrange and pack it by following these steps:

1. Separate the module from the Precellys® lid.



2. Disconnect both fan and board interface connectors from their respective connections at the back of the Precellys® Evolution Touch.



3. Unscrew the 2 screws on the cover of the Precellys® Evolution Touch.



4. Detach the hinge reinforcement from the hinge on the Precellys® Evolution Touch.



5. Lift the lid off the Precellys® Evolution Touch.



6. Replace the module on top of the Precellys® lid and place the entire unit inside the foam protector and on the inner box.



7. Place the top foam protector over the Cryolys® Evolution.



8. Close the inner box.



9. Place inside the main cardboard box using the handle.





3.3. Storage

The device must be stored in a dry location at a temperature between +0°C and +50°C on a horizontal surface.

The device may be stored after checking the following points:

1. The module is empty
2. The device is dry, clean and decontaminated

4. USE

4.1. Description of the user interface

4.1.1. Main interface



Figure 4: Precellys® Evolution Touch main interface screen

- ① **Mixer protocol settings interface:** see Precellys® Evolution Touch user manual 23405-800-DU002-A.
- ② **Cooling protocol settings' interface:** allows you to set the various parameters of the Cryolys® Evolution.
Note: the temperature display disappears and the Cryolys® Evolution interface is grayed-out and deactivated.
- ③ **Current temperature:** indicates the temperature under the Precellys® lid.
- ④ **Cryolys® Evolution module activation field (ON/OFF) :** allows you to activate or deactivate the Cryolys® Evolution
- ⑤ **Operating temperature selection field:** allows you to set the temperature between 0 and 10°C
- ⑥ **Operating mode selection field:** allows you to choose manual or automatic mode

Note: for information about navigating the Precellys® Evolution from the screen interface, please refer to the Precellys® Evolution user manual (23405-800-DU002-A).

4.2 Starting temperature-controlled homogenization

4.2.1 Installing your Cryolys® Evolution

Use of the Cryolys® Evolution requires dry ice sticks.

Note: Wear personal protection equipment (PPE) as described in paragraphs 1.1.2 and 1.1.3.



Do not inhale dry ice vapors: risk of asphyxia.
Ensure the dry ice source container is closed after filling the Cryolys® Evolution.
Use the device in a ventilated area.

1. Fill the cooling module with dry ice

Note: Fill the cooling module up to the level of the interior fins to optimize the production of cool air.

2. Close the cooling module with the cover

3. Clip the cooling module to the Precellys® lid

4.2.2 Prepare the samples

1. Place the samples into the Precellys tubes and add the required buffer if necessary

Note: Bertin Instruments recommends the use of the Precellys® Lysing Kits.

2. Close the tubes and arrange them ad hoc in the tube holder

Note: Bertin Instruments guarantees the compatibility of all Precellys® consumables and accessories with the Cryolys® Evolution

4.2.3 Homogenizing the samples

Select a saved program or use the «work» function (See the Precellys® Evolution Touch user manual 23405-800-DU002-A)

Note: Saved protocols must include Cryolys® Evolution parameters. The Cryolys® Evolution module's activation field must be set to ON. The Cryolys® Evolution allows two operating modes, one automatic and one manual.



Do not open the Precellys® Evolution Touch lid or the cooling module cover until the cycle completes.

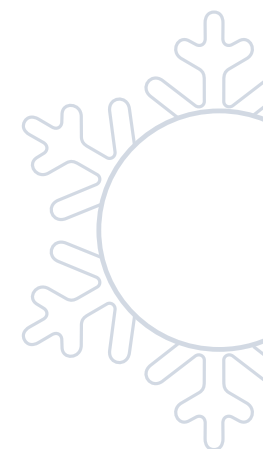

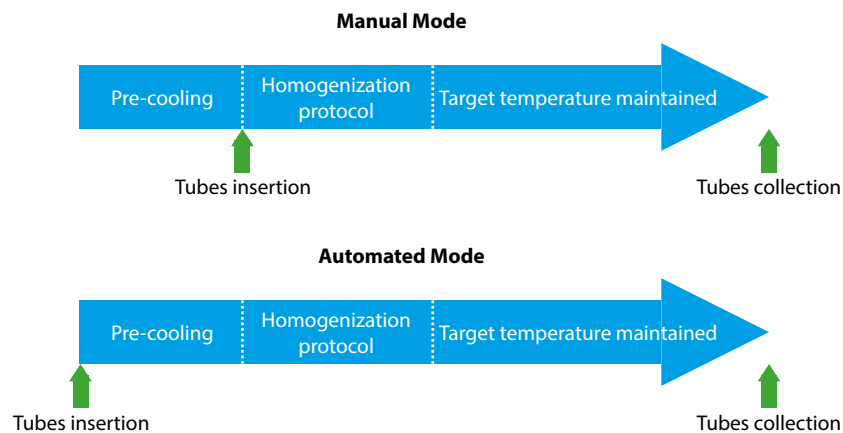

Figure 5: diagram showing automatic and manual modes

- 1 Program the homogenization parameters via the dedicated interface: volume, speed, number & duration of cycle and pause
- 2 Program cooling parameters via the dedicated interface: ON/OFF, temperature and mode

Note: You can use a saved protocol if the Cryolys® Evolution module activation field is set to ON.

Automatic mode

- 3a Place the tubes and tube holder (fitted with the plate) into the Precellys® Evolution (refer to the Precellys® Evolution Touch user manual 23405-800-DU002-A)
- 4a Close the Precellys® lid
- 5a Press the START button on the Precellys® Evolution Touch
Note: When the chosen temperature is reached, the following message appears: «Temp. is reached.» Protocol starting». The homogenization cycle starts.



- 6a At the end of the cycle, open the Precellys® lid and retrieve the tubes and the tube holder
- 7a Insert new samples and close the Precellys® lid
Note: Ensure that the volume of dry ice is sufficient. If no more homogenization is required, empty the cooling module.

Manual mode

- 3m Close the Precellys® lid
- 4m Press the START button on the Precellys® Evolution
- 5m When the chosen temperature is reached, the following message appears: «Temp. is reached.» Open the Precellys® lid
- 6m Place the tubes and the tube holder (fitted with the plate) into the Precellys® Evolution (refer to the Precellys® Evolution Touch user manual 23405-800-DU002-A)
- 7m Close the Precellys® lid
- 8m Press the START button on the Precellys® Evolution
- 9m At the end of the cycle, open the Precellys® lid and retrieve the tubes and the tube holder
- 10m Insert new samples and close the Precellys® lid
Note: Ensure that the volume of dry ice is sufficient. If no more homogenization is required, empty the cooling module.



4.2.4 End of cycle

If there are no more tests to carry out:

1. Empty the dry ice from the Cryolys® Evolution into a suitable container.
2. Clean the Cryolys® Evolution using a wipe (reservoir, reservoir air outlet, interior of diffuser module, etc.).
3. Turn the Cryolys® Evolution switch to OFF.



Avoid all direct contact between your skin and cold parts of the Precellys® Evolution Touch and Cryolys® Evolution. Do not heat up the dry ice using a hair dryer or similar in order to accelerate evaporation. Handle only with suitable gloves whenever the module contains dry ice.

If using the Precellys® Evolution Touch without cooling, ensure that the Cryolys® Evolution is fitted to the diffusion cover to avoid any projectiles in the event of a leak from a tube.



5. CLEANING AND DECONTAMINATION

5.1. Recommendations

The device must be stored in a dry location at a temperature between +0°C and +50°C on a horizontal surface.

- ▶ Do not spray anything directly onto the device, particularly on the electrical connectors.
- ▶ Clean the instrument when it is unplugged.
- ▶ Do not use a sponge-scourer to avoid damage to the device.
- ▶ Do not use an airborne decontamination process.
- ▶ Do not use caustic soda crystals or acetone which will irreparably damage the equipment.
- ▶ Immediately remove any surplus liquids using a dry cloth.

The exterior of the device can be cleaned using a sponge or cloth which has been dampened with water or household alcohol.

5.2. Decontamination protocol

In the event of splashing, any parts that might have been contaminated by infectious agents must be decontaminated using a suitable disinfectant. The user alone is responsible for the choice of decontamination procedure.

Any parts that might have been contaminated may, for example, be cleaned using a wipe dipped in bleach diluted to 6° Cl.

6. SUPPORT AND DOCUMENTATION

6.1. Frequently asked questions

Before transporting the device, you must:

1. Check that there is absolutely no dry ice inside the module
2. Ensure there is no humidity or, if necessary, dry any humid areas

If you have to transport or ship the Cryolys® Evolution, arrange and pack it by following these steps:

Questions	Answers
Can the Cryolys® Evolution fall off when I open the cover of the Precellys® Evolution Touch?	We recommend separating the cooling module containing dry ice from the cover when operating the cover
Can I use any type of ice (ice cubes, blue ice, ice gel, etc.) instead of dry ice?	The Cryolys® Evolution must absolutely be used with dry ice sticks only
Is it possible to save a protocol's cooling parameters?	Just as for Precellys® Evolution protocols, you can save a protocol using the Cryolys® Evolution. Homogenization and cooling parameters will be saved simultaneously.
What is the maximum/minimum quantity of dry ice that I can place inside the Cryolys® Evolution?	We recommend a minimum of 0.5 kg of dry ice in the module which appears as a uniform layer across the bottom of the module. The maximum is defined by your ability to close the module cover, or around 1.5 kg of dry ice..

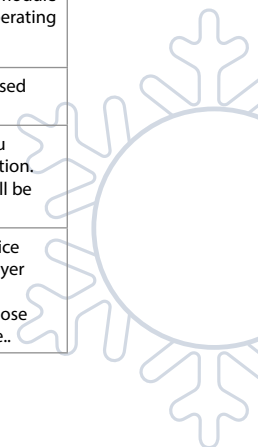



6.2. Troubleshooting

Problem encountered	Possible cause(s)	Action(s) to be performed
Message appears: «No Cryolys® Evolution has been detected»	Module is badly positioned	Reposition the module on the Precellys® lid.
	Bad connection	1.Check that the interfaceboard connector is plugged in 2.Check the state of the interface board, its cable and connector.
Message «Temp. not reached» or «Temp. not maintained during protocol» appears	Not enough dry ice	Check that the dry ice covers at least the center of the reservoir.
	The cooling system is not receiving any air	1.Check that the fan connector is plugged in 2.Check the state of the fan, its cable and connector.
	Diffuser holes are blocked	Wait for the interior of the module to defrost.
Cut the power		Disconnect the Precellys® Evolution from the power supply

If any of these faults persist, contact technical support (see 6.3 Support).

6.3. Support

If, despite the information contained in this manual, you are still unable to resolve your problem, please contact your distributor.

For the latest information about our services and support, please go to our website <http://www.bertin-technologies.com>.

You can also contact the Bertin Instruments team via email at: sample-prep@bertin.fr

6.4. Disposal

This equipment is subject to selective collection in accordance with the European directive on waste electrical and electronic equipment (WEEE) 2012/19/EU.



Bertin Technologies is responsible for treatment of WEEE for products sold in France (via RECYLUM). For other countries, the importer is responsible for treatment and this waste treatment is dependent on current regulations.

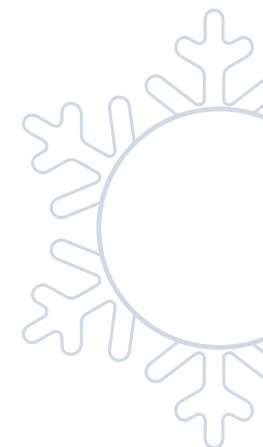



7. APPENDIX: EXAMPLE OF CE DECLARATION

7. APPENDIX: EXAMPLE OF CE DECLARATION



EC Declaration of Conformity

MANUFACTURER: Bertin Technologies

Headquarters: Parc d'Activité du Pas du Lac
10 bis avenue Ampère
Montigny-Lez-Lille - FRANCE

Postal address: Boite Technic 214
91018 Saint-Leger-en-Yvelines Cedex - FRANCE

DECLARES THAT THE EQUIPMENT REFERENCED BELOW:

- Designation: Advanced temperature controller
- Type: CRYOLYS EVOLUTION
- Reference: E00011-300-200010
- Serial number: 0001 to 100
- Manufacturing year: 2017

CONFORMS TO:

- The Machinery Directive 2006/42/EC
- The Low voltage Directive 2014/35/EU
- The EMC Directive 2014/53/EU
- The Directive 2011/65/EU on restriction of the use of certain hazardous substances in electrical and electronic equipment
- The standard FCC part 15 and part 18

Done at: *Montigny* Date: *11-07-2017*

Name: *Jean Rich*
Position: 
Vice: 

BERTIN TECHNOLOGIES
Parc d'Activité du Pas du Lac - 10 bis, avenue Ampère
BP 204 - 70058 Saint-Leger-en-Yvelines Cedex
FR - 91 700 000
020 402 811 800 (France) - 0033 3 1 71 12 79

Person authorized to create the technical file:
Bertin Technologies, 10 bis avenue Ampère - Montigny-lez-Lille - France

Model: CRYOLYS Evolution
Date: 11-07-2017
Version: 1.0
F00011-300-200010

Cryolys Evolution

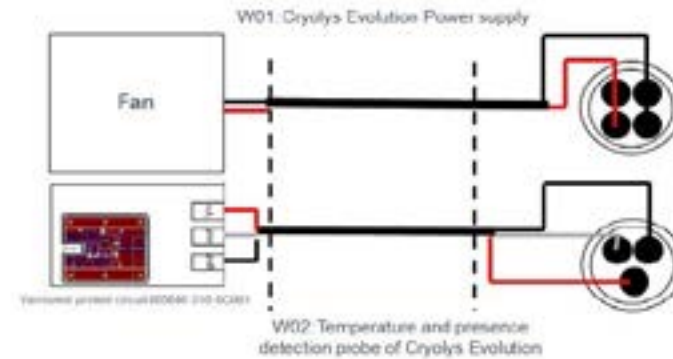

Precellys Evolution Rear panel

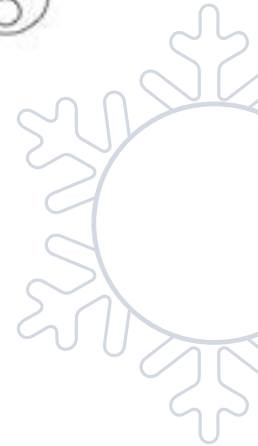



Precellys 24 Touch
The Original



Minilys
The Individual



Precellys
Evolution Touch



Precellys
Lysing Kits

More than 1000 scientific protocols and data on the application center
Join the Precellys community now!

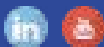

Bertin Technologies

10 bis, avenue Ampère, 78180 Montigny-le-Bretonneux, France

www.bertin-technologies.com